

Notes

- 1) Drawings are not to scale.
- 2) Dimensions are in feet and inches. Weights are in pounds and include options and accessories.
- 3) Unless otherwise indicated, connections 3" and smaller are MPT.
- 4) Dimensions showing location of coil & basin connections are approximate and should not be used for prefabrication of connecting piping.
- 5) For weight loadings and support requirements, refer to suggested steel support drawing.
- 6) Area above the air discharge must be unobstructed.
- 7) Field piping must not be supported by the unit inlet or outlet connections.
- 8) For belt drive units, M = Motor location, M1 = Large Motor Location, M2 = Small Motor Location.

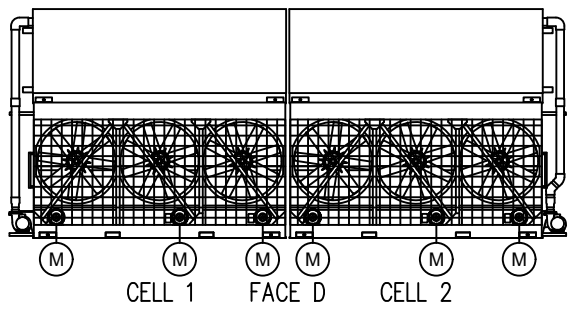
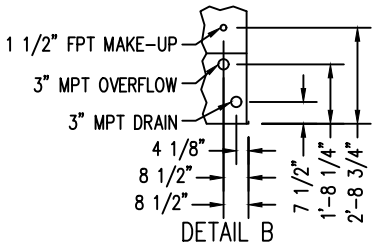
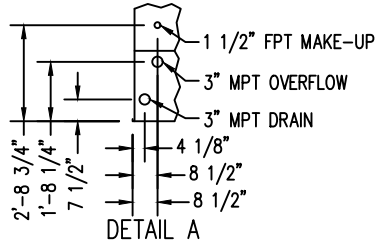
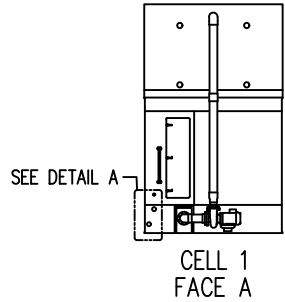
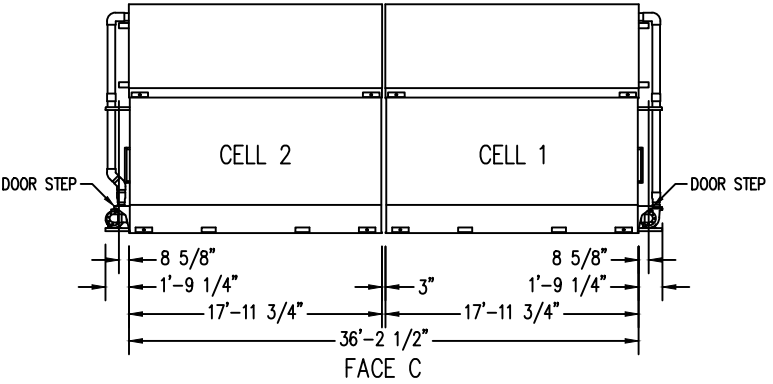
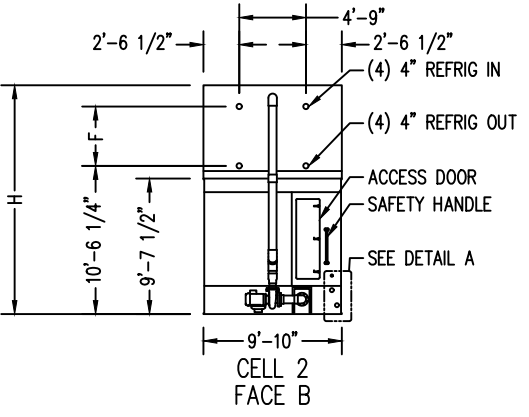
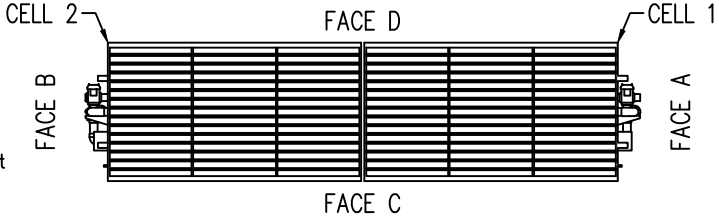

MODEL NO.	APPROX. SHIPPING WEIGHT	APPROX. OPERATING WEIGHT	HEAVIEST SECTION (COIL)	F	H
VRC-0653B-1036N-HA	34850	47570	9330	3'-7 1/16"	15'-7 11/16"
VRC-0771B-1036N-KA	35370	48090	9330	3'-7 1/16"	15'-7 11/16"
VRC-0724B-1036N-HA	37540	50520	10680	3'-7 1/16"	15'-7 11/16"
VRC-0796B-1036N-JA	37910	50900	10680	3'-7 1/16"	15'-7 11/16"
VRC-0853B-1036N-KA	38060	51040	10680	3'-7 1/16"	15'-7 11/16"
VRC-0865B-1036N-JA	42600	55860	13020	4'-10 1/16"	16'-10 11/16"
VRC-0927B-1036N-KA	42750	56000	13020	4'-10 1/16"	16'-10 11/16"
VRC-1004B-1036N-KA	45050	58530	14170	4'-10 1/16"	16'-10 11/16"
VRC-1106B-1036N-LA	46020	59500	14170	4'-10 1/16"	16'-10 11/16"

Right & Left Hand Unit

ORDER NO:

DATE:



**Vertex™ Evaporative Condenser  
10x36 Two Cell Unit Print**

DRAWING NUMBER: