

- Notes
- 1) Drawings are not to scale.
  - 2) Dimensions are in feet and inches. Weights are in pounds and include options and accessories.
  - 3) Unless otherwise indicated, connections 3" and smaller are MPT.
  - 4) Dimensions showing location of coil & basin connections are approximate and should not be used for prefabrication of connecting piping.
  - 5) For weight loadings and support requirements, refer to suggested steel support drawing.
  - 6) Area above the air discharge must be unobstructed.
  - 7) Field piping must not be supported by the unit inlet or outlet connections.
  - 8) For belt drive units, M = Motor location, M1 = Large Motor Location, M2 = Small Motor Location.

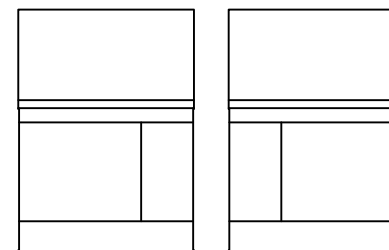
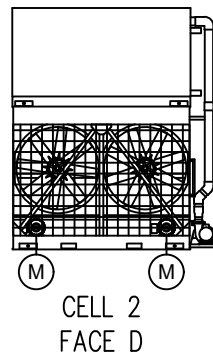
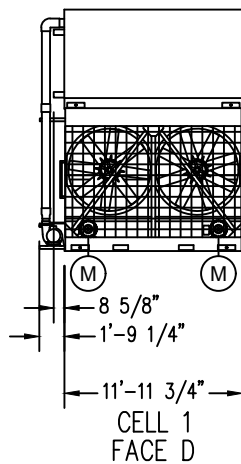
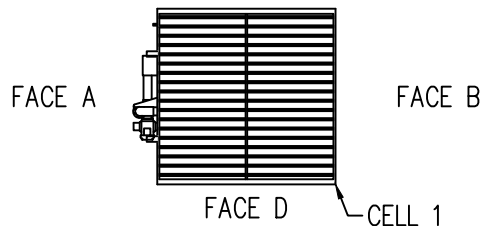
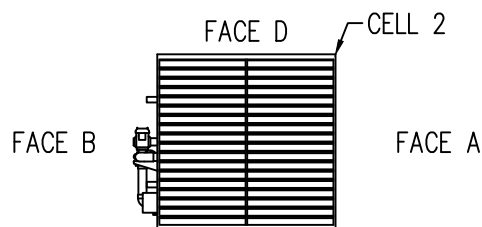
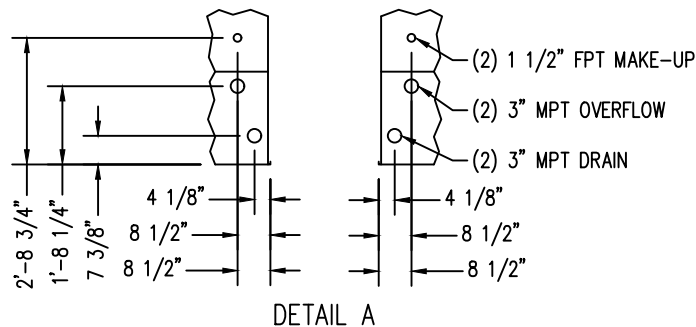
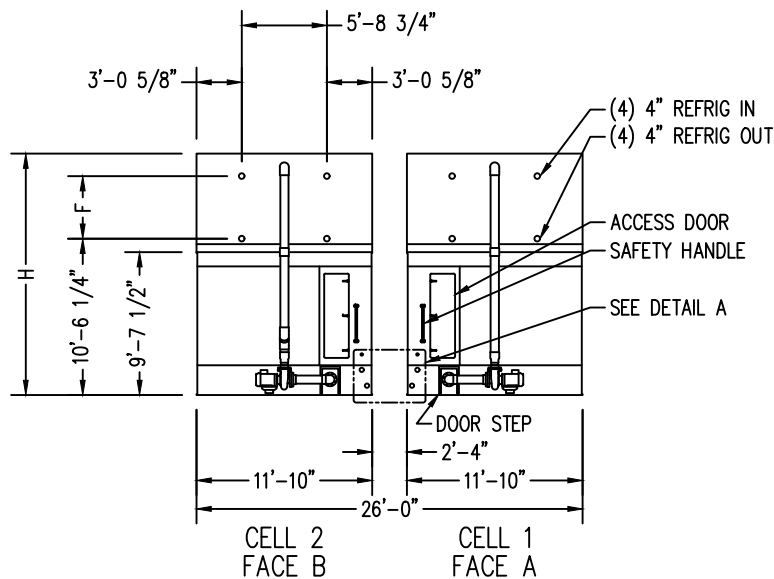

MODEL NO.	APPROX. SHIPPING WEIGHT	APPROX. OPERATING WEIGHT	HEAVIEST SECTION (COIL)	F	H
VRC-0429B-2412N-GA	28590	38130	7890	3'-7 1/16"	15'-7 11/16"
VRC-0486B-2412N-HA	28590	38120	7890	3'-7 1/16"	15'-7 11/16"
VRC-0535B-2412N-JA	28840	38370	7890	3'-7 1/16"	15'-7 11/16"
VRC-0574B-2412N-KA	28940	38470	7890	3'-7 1/16"	15'-7 11/16"
VRC-0541B-2412N-HA	30830	40570	9010	3'-7 1/16"	15'-7 11/16"
VRC-0597B-2412N-JA	31080	40820	9010	3'-7 1/16"	15'-7 11/16"
VRC-0641B-2412N-KA	31170	40920	9010	3'-7 1/16"	15'-7 11/16"
VRC-0697B-2412N-KA	35790	45770	11320	4'-10 1/16"	16'-10 11/16"
VRC-0768B-2412N-LA	36440	46410	11320	4'-10 1/16"	16'-10 11/16"
VRC-0824B-2412N-MA	36690	46660	11320	4'-10 1/16"	16'-10 11/16"
VRC-0763B-2412N-KA	37760	47910	12300	4'-10 1/16"	16'-10 11/16"
VRC-0831B-2412N-LA	38410	48560	12300	4'-10 1/16"	16'-10 11/16"
VRC-0889B-2412N-MA	38660	48810	12300	4'-10 1/16"	16'-10 11/16"
VRC-0939B-2412N-NA	38810	48970	12300	4'-10 1/16"	16'-10 11/16"

Right & Left Hand Unit

ORDER NO:

DATE:



**BALTIMORE AIRCOIL COMPANY**

**Vertex™ Evaporative Condenser  
24x12 Two Cell Unit Print**

DRAWING NUMBER: