

Notes

- 1) Drawings are not to scale.
- 2) Dimensions are in feet and inches. Weights are in pounds and include options and accessories.
- 3) Unless otherwise indicated, connections 3" and smaller are MPT.
- 4) Dimensions showing location of coil & basin connections are approximate and should not be used for prefabrication of connecting piping.
- 5) For weight loadings and support requirements, refer to suggested steel support drawing.
- 6) Area above the air discharge must be unobstructed.
- 7) Field piping must not be supported by the unit inlet or outlet connections.

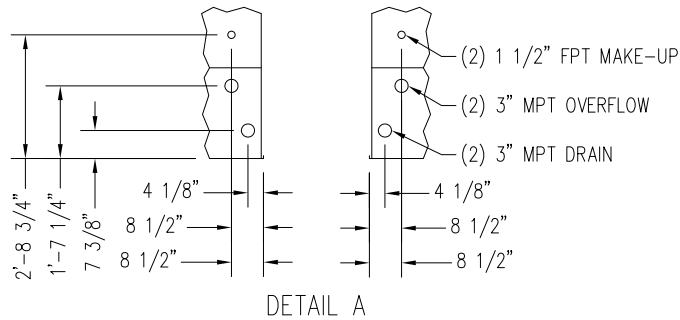
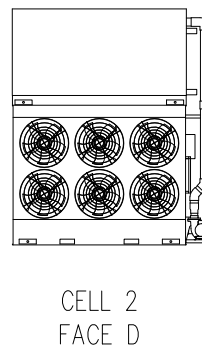
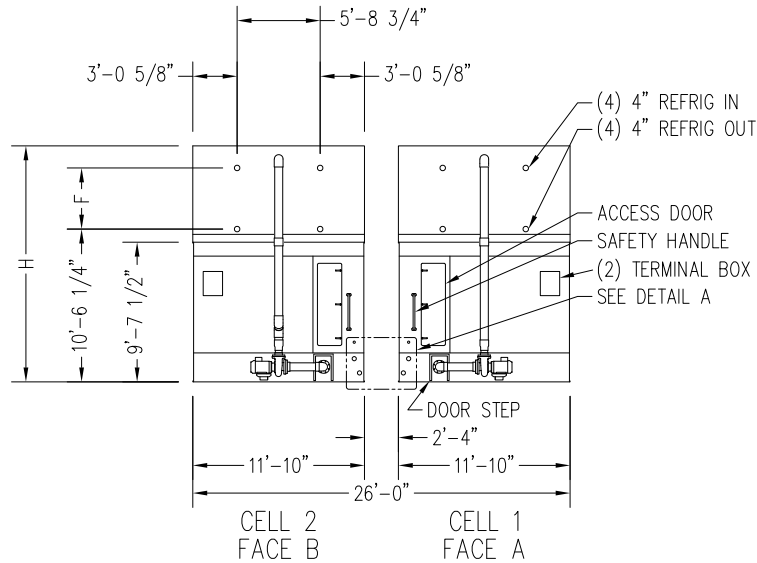
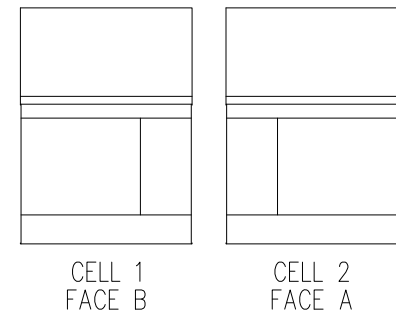
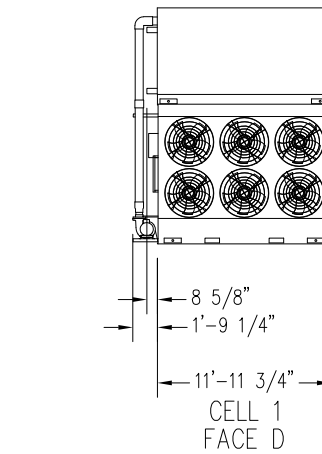
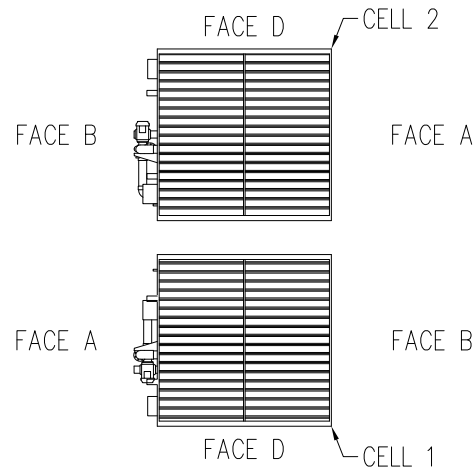

MODEL NUMBER	APPROX. SHIPPING WEIGHT	APPROX. OPERATING WEIGHT	HEAVIEST SECTION (COIL)	F	H
VRC-0628B-2412N-HB	27,990	37,560	7,890	3'-7"	15'-8"
VRC-0694B-2412N-HB	30,230	40,010	9,010	3'-7"	15'-8"
VRC-0695B-2412N-JB	27,990	37,560	7,890	3'-7"	15'-8"
VRC-0755B-2412N-HB	34,850	44,860	11,320	4'-10"	16'-11"
VRC-0767B-2412N-JB	30,230	40,010	9,010	3'-7"	15'-8"
VRC-0810B-2412N-HB	36,810	47,010	12,300	4'-10"	16'-11"
VRC-0835B-2412N-JB	34,850	44,860	11,320	4'-10"	16'-11"
VRC-0895B-2412N-JB	36,810	47,010	12,300	4'-10"	16'-11"

Right & Left Hand Unit

ORDER NO:

DATE:



**BALTIMORE AIRCOIL COMPANY**

**Vertex™ Evaporative Condenser  
24x12 Two Cell Unit Print**

DRAWING NUMBER: